

Вид снизу

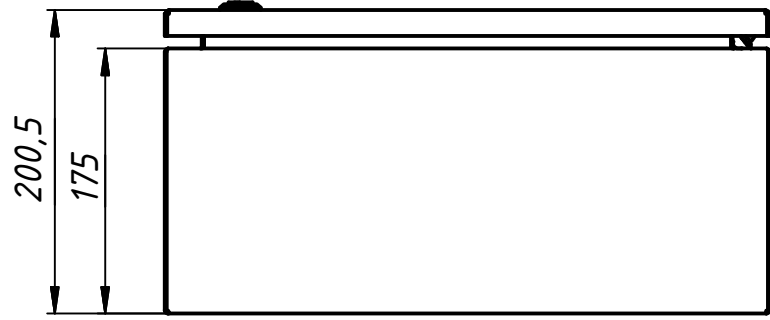

A

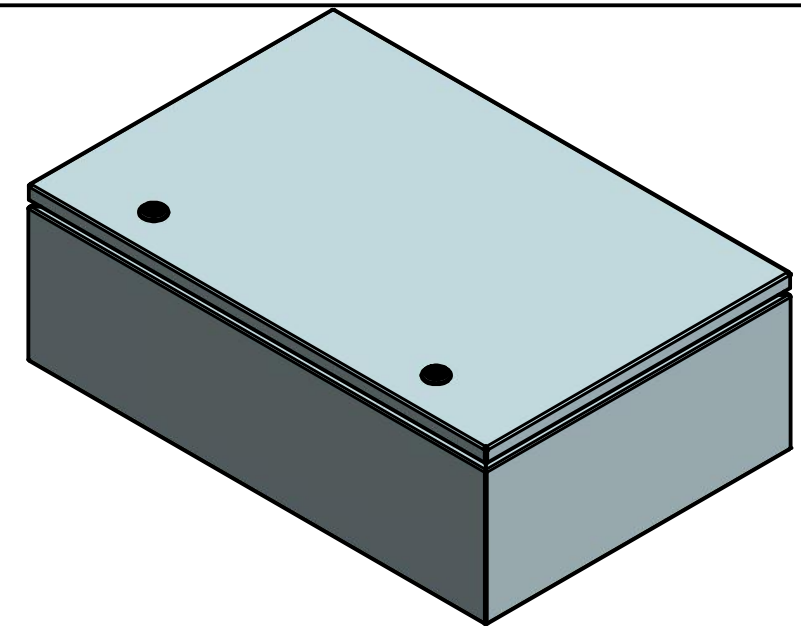
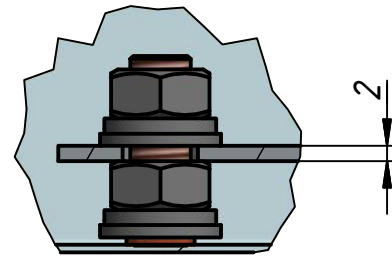

Вид справа

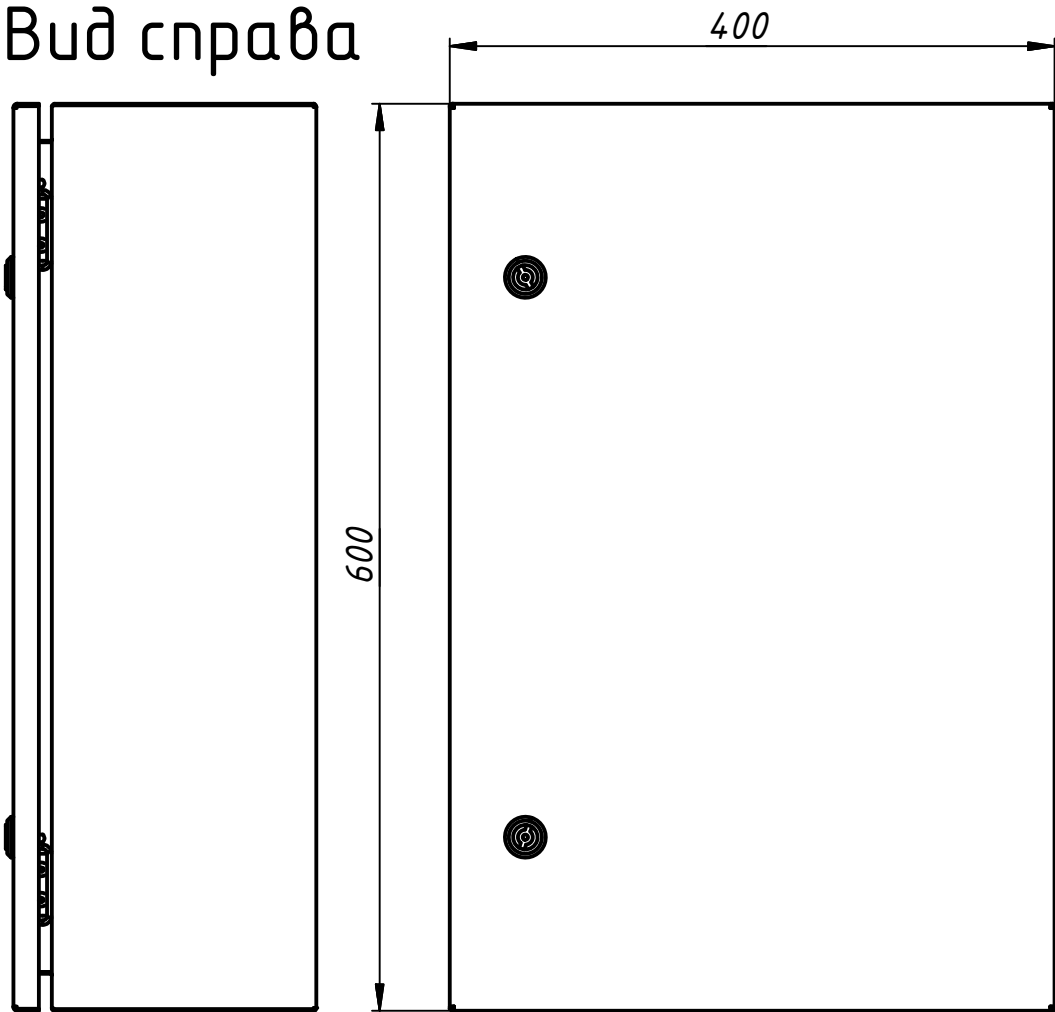

Вид слева

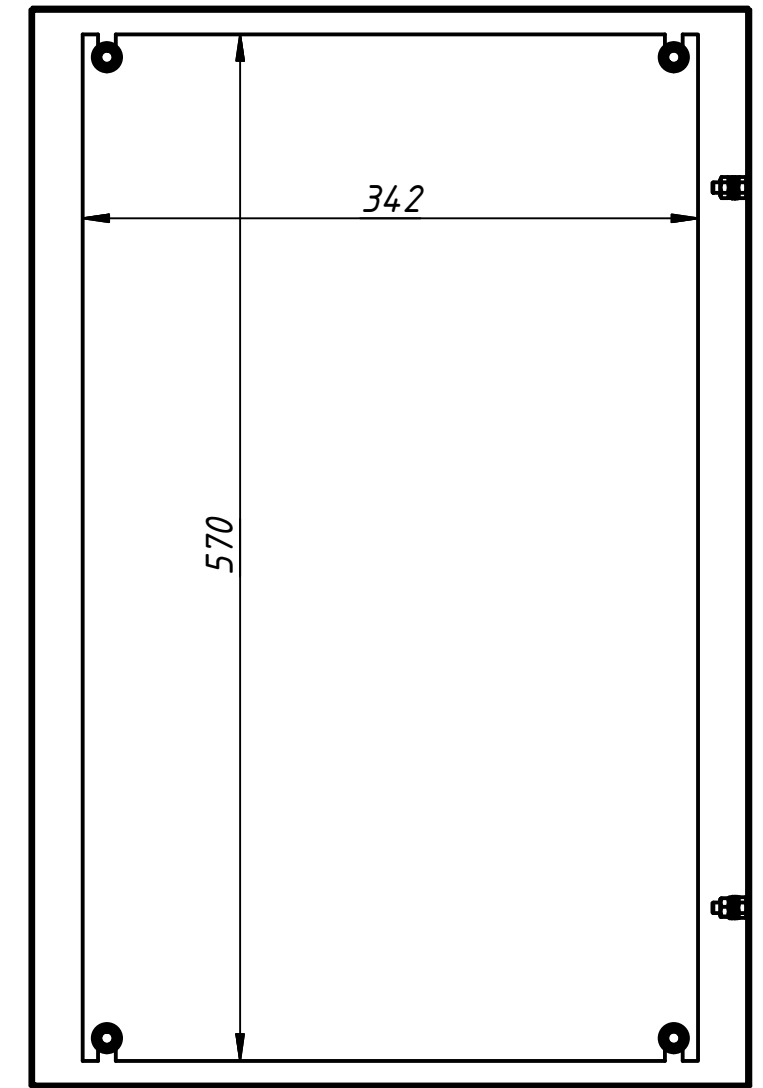
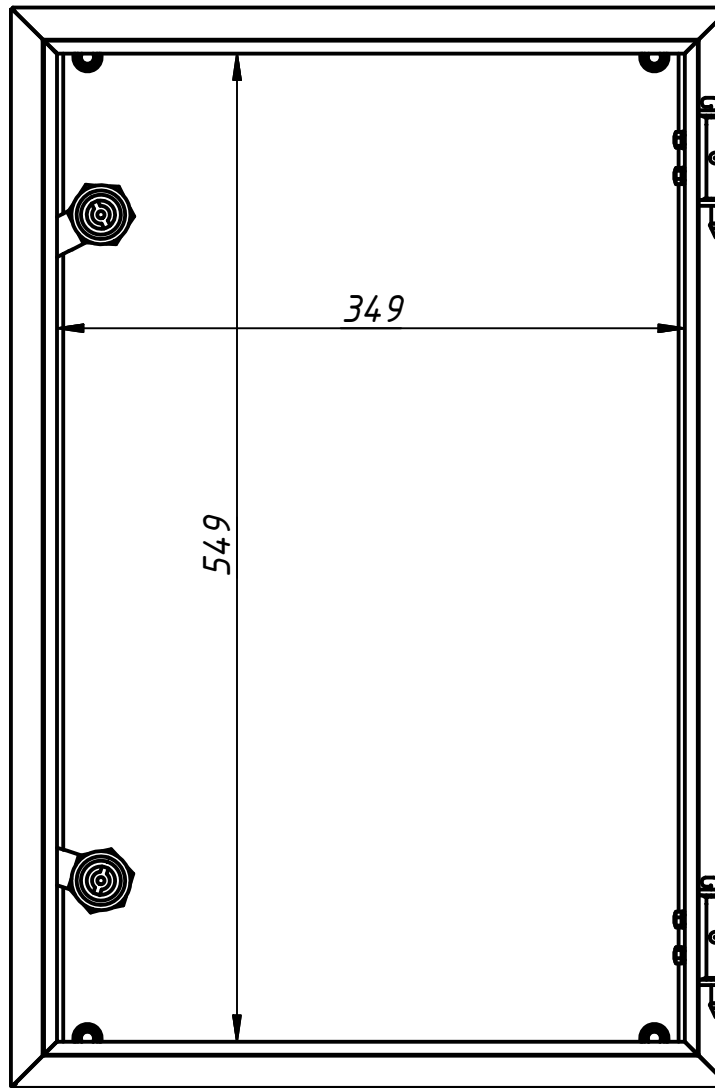
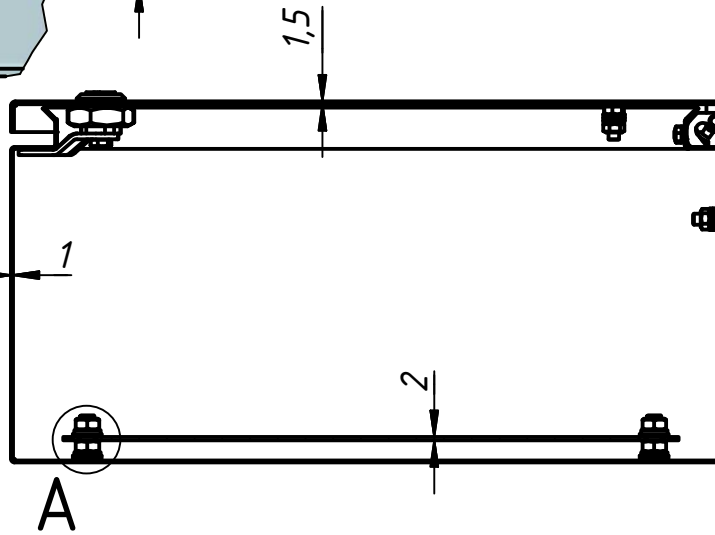
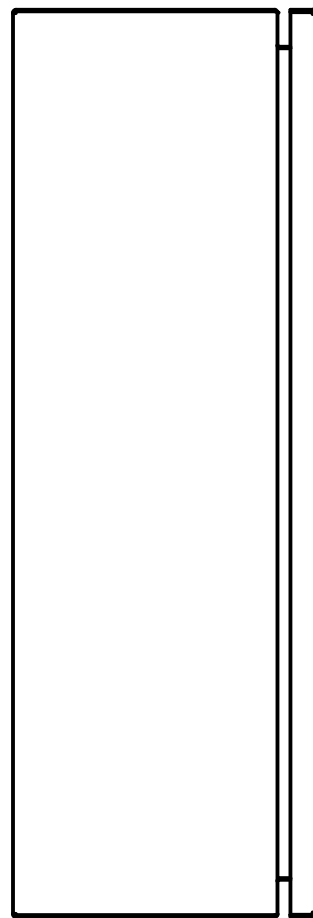

Вид сверху

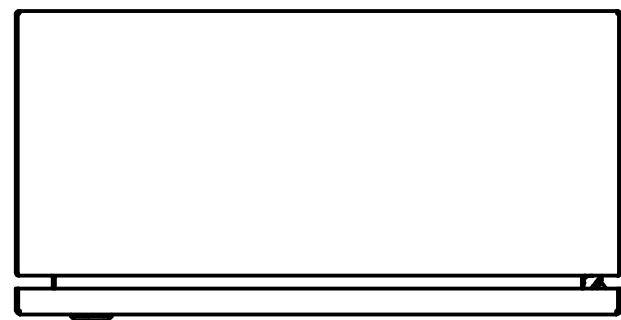

Изм.	Лист	№ докум.	Подп.	Дата